



SECRET JARDIN

ASSEMBLY INSTRUCTIONS



DARK ROOM R4.00

LINKABLE

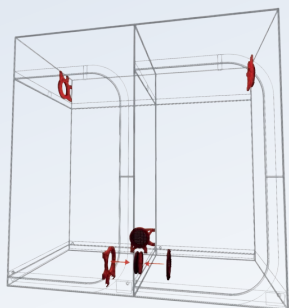

CONNECTABLE

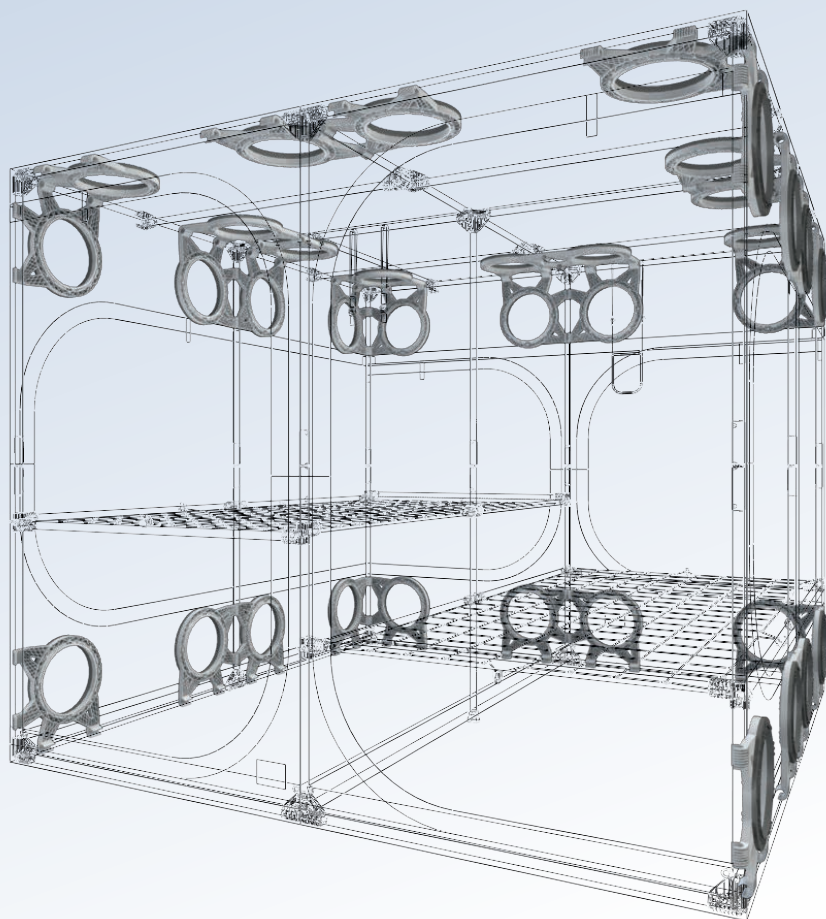

VIDEOS TENTS

**VIDEO ASSEMBLY
DR240W**



**VIDEO ASSEMBLY
DR300**



SPACE BOOSTER, WEBIT, DUCTING & CABLE FLANGES

**VIDEO ASSEMBLY
DUCTING FLANGE**



**VIDEO ASSEMBLY
CABLE FLANGE**



**VIDEO ASSEMBLY
SPACE BOOSTER**





DUCTING FLANGE Ø25



Ducting Flange



Cutting Tool



Connectors

150 - 160 - 200 - 250 mm
6" - 6½" - 8" - 10"



Light Baffle

CABLE FLANGE Ø7



Cable Flange



Cutting Tool

GENERAL



Space Booster



Removable Liner

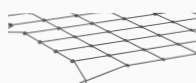

WebIT



PocketIT



Pair HookIT



CableIT



StrapIT

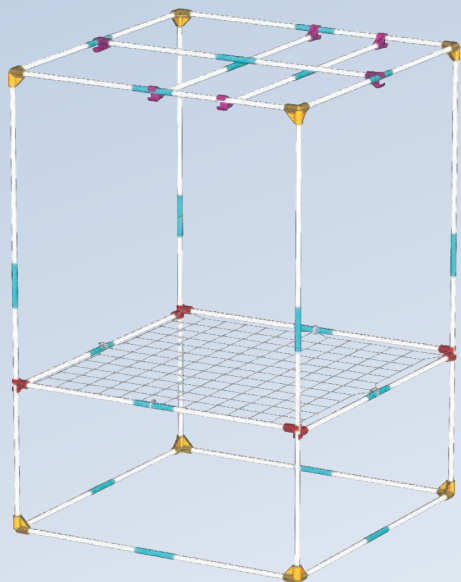
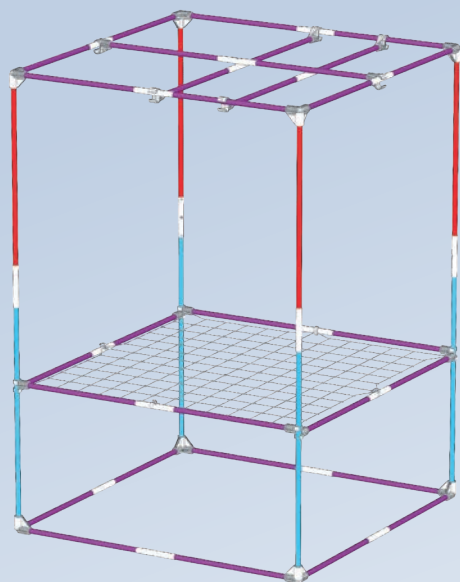

- 4x T25-120
- 4x T25-100
- 30x T25-75
- 19x T25-Link



8x C25-Y



8x C25-SB



6x C25-H

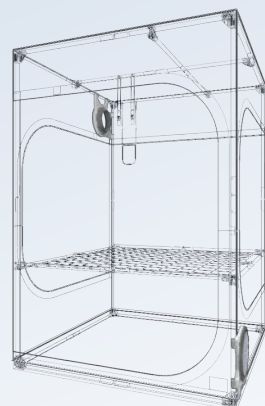

**VIDEO ASSEMBLY
TENT DR120**



**VIDEO ASSEMBLY
DUCTING FLANGE**



**VIDEO ASSEMBLY
CABLE FLANGE**



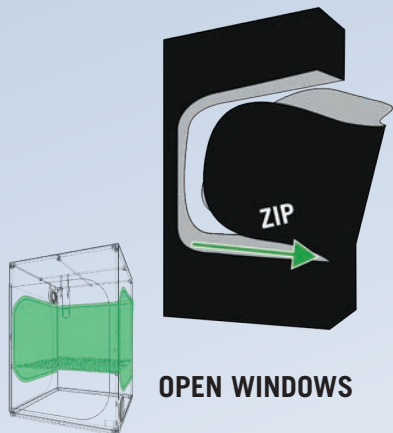

OPEN WINDOWS

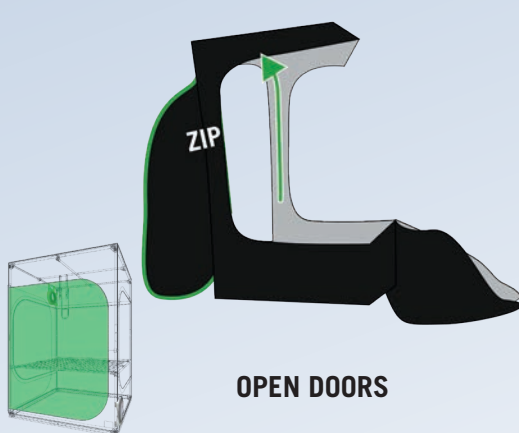

OPEN DOORS



OPEN ALL ACCESSES **THEN**
PUT THE CANVAS ON



ALLE ZUGÄNGE ÖFFNEN **DANN**
LEGEN SIE DIE LEINWANDE AB



OUVRIER TOUT LES ACCÈS **PUIS**
METTRE LA TOILE



ALLE TOEGANGEN OPENSTELLEN
DAN ZET JE HET DOEK OP



ABRIR TODOS LOS ACCESOS
LUEGO PONTE EL LIENZO



APRIRE TUTTI GLI ACCESSI **POI**
METTERE LA TELA DI CANAPA SU

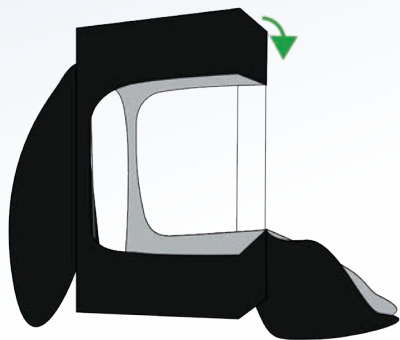
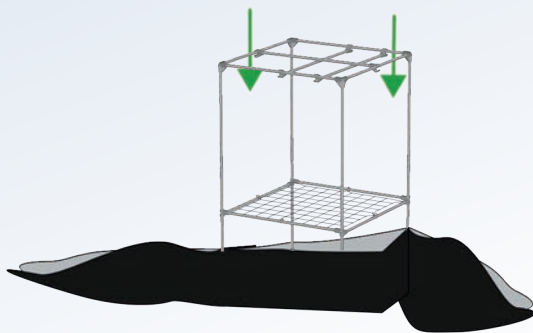

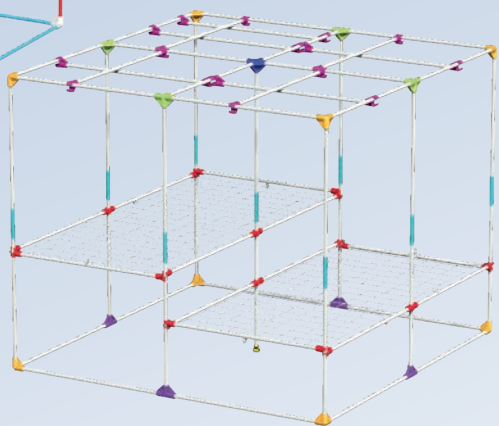
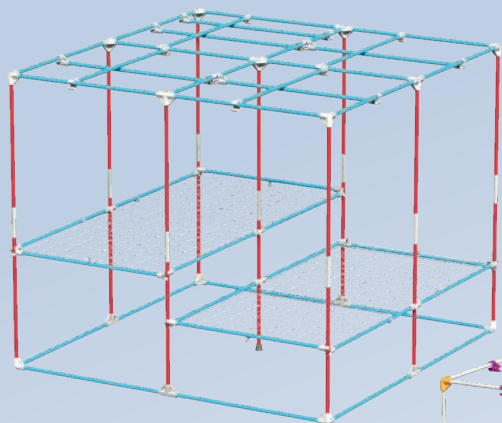

**VIDEO ASSEMBLY
TENT DR300**



41x T25-120

18x T25-100

9x T25-Link



8x C25-Y

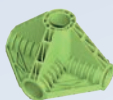

4x C25-K



4x C25-T



1x C25-XI



1x C25-RF



24x C25-SB



18x C25-H

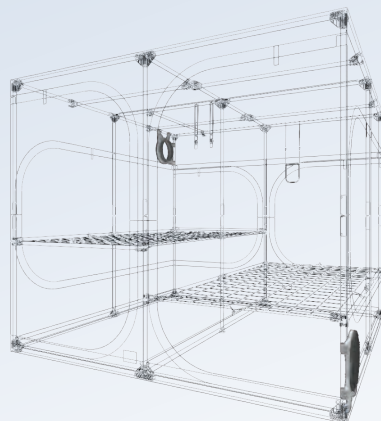

**VIDEO ASSEMBLY
DUCTING FLANGE**



**VIDEO ASSEMBLY
CABLE FLANGE**



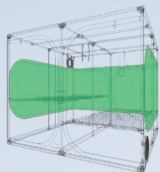
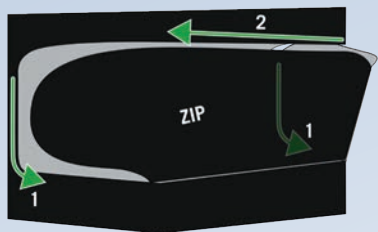

OPEN WINDOWS

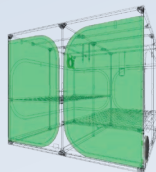
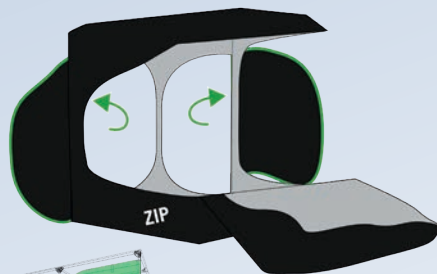

OPEN DOORS



OPEN ALL ACCESSES THEN PUT THE CANVAS ON



ALLE ZUGÄNGE ÖFFNEN DANN LEGEN SIE DIE LEINWANDE AB



OUVRIR TOUT LES ACCÈS PUIS METTRE LA TOILE



ALLE TOEGANGEN OPENSTELLEN DAN ZET JE HET DOEK OP



ABRIR TODOS LOS ACCESOS LUEGO PONTE EL LIENZO



APRIRE TUTTI GLI ACCESSI POI METTERE LA TELA DI CANAPA SU

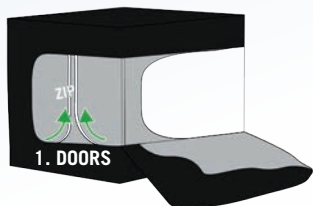
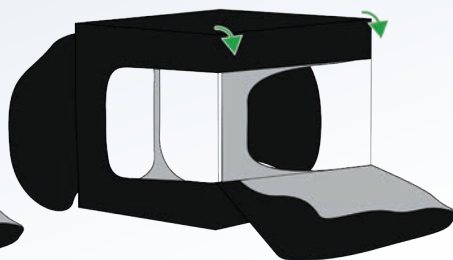
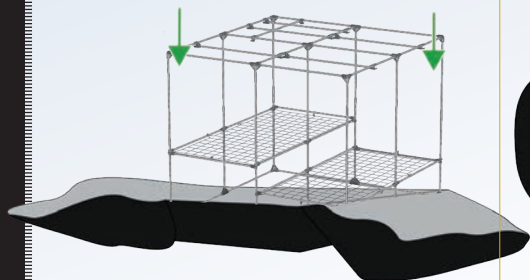

1. DOORS

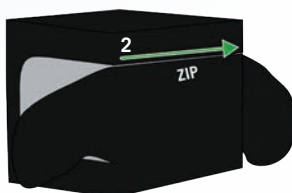

CLOSE DETACHABLE ZIP

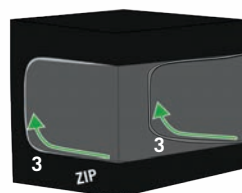

CLOSE ZIP

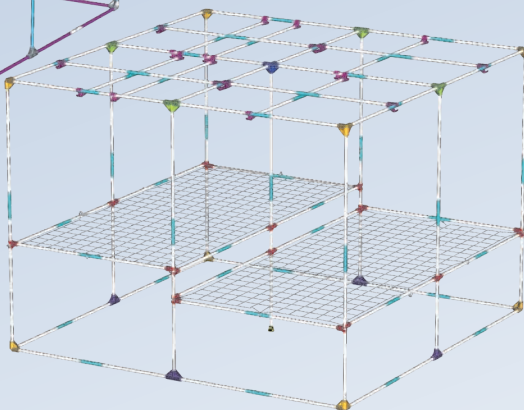
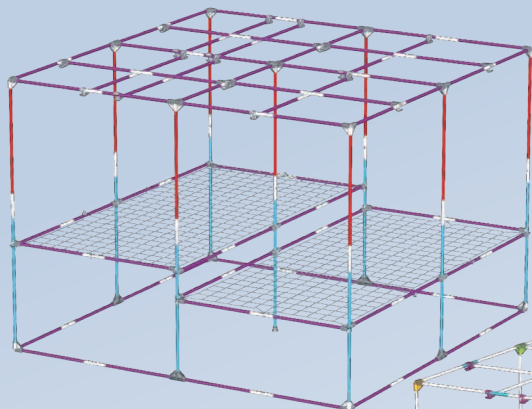

**VIDEO ASSEMBLY
TENT DR300**



- 9x T25-120
- 9x T25-100
- 84x T25-75
- 51x T25-Link
- 8x C25-Y
- 4x C25-K
- 4x C25-T
- 1x C25-XI
- 1x C25-RF
- 24x C25-SB
- 20x C25-H

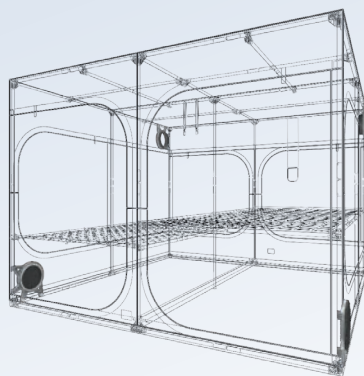

**VIDEO ASSEMBLY
DUCTING FLANGE**



**VIDEO ASSEMBLY
CABLE FLANGE**



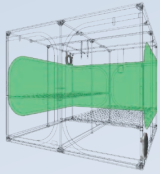
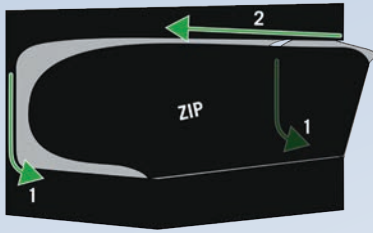

OPEN WINDOWS

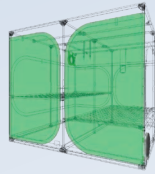
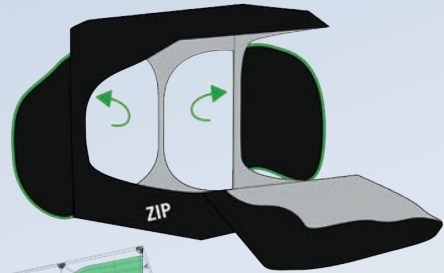

OPEN DOORS



OPEN ALL ACCESSES **THEN**
PUT THE CANVAS ON



ALLE ZUGÄNGE ÖFFNEN **DANN**
LEGEN SIE DIE LEINWANDE AB



OUVRIER TOUT LES ACCÈS **PUIS**
METTRE LA TOILE



ALLE TOEGANGEN OPENSTELLEN
DAN ZET JE HET DOEK OP



ABRIR TODOS LOS ACCESOS
LUEGO PONTE EL LIENZO



APRIRE TUTTI GLI ACCESSI **POI**
METTERE LA TELA DI CANAPA SU

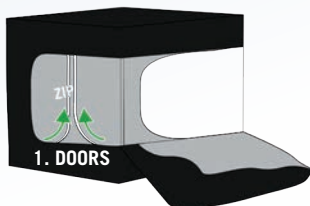
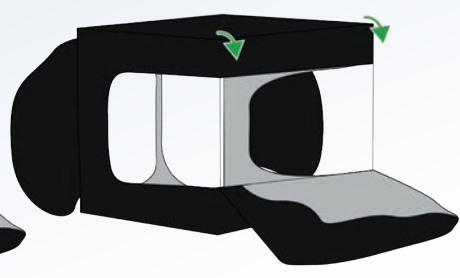
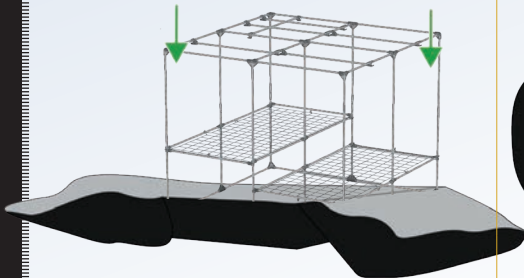

1. DOORS

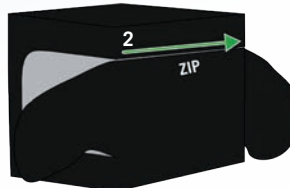

**CLOSE
DETACHABLE ZIP**

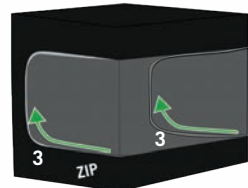

CLOSE ZIP

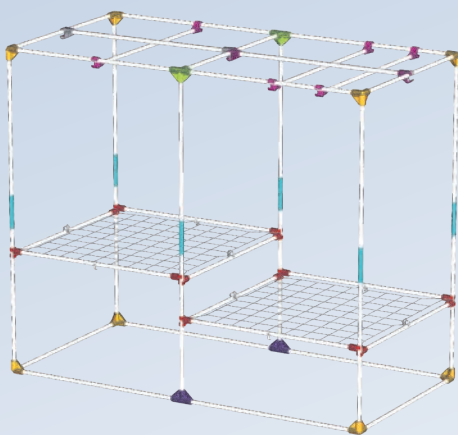
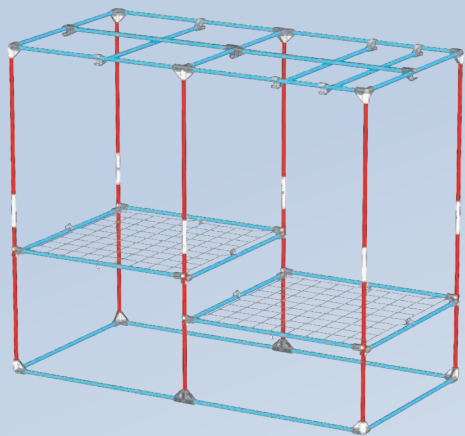

**VIDEO ASSEMBLY
TENT DR240W**



26x T25-120

12x T25-100

6x T25-Link



8x C25-Y

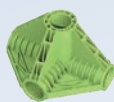

2x C25-K



2x C25-T



16x C25-SB



10x C25-H

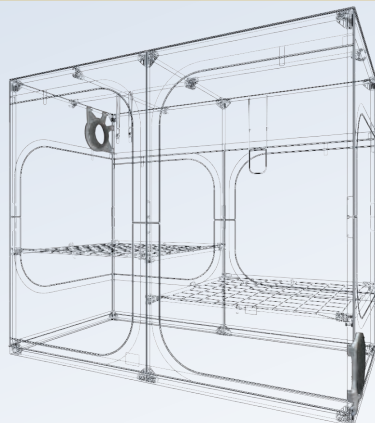

**VIDEO ASSEMBLY
DUCTING FLANGE**



**VIDEO ASSEMBLY
CABLE FLANGE**



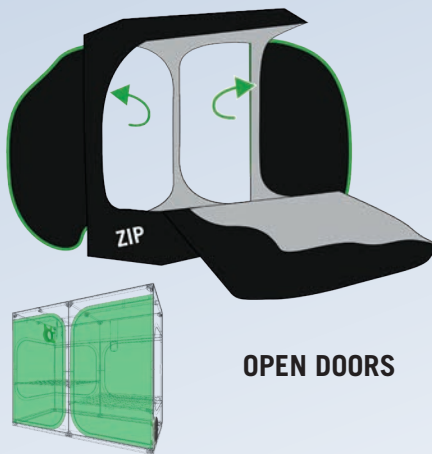
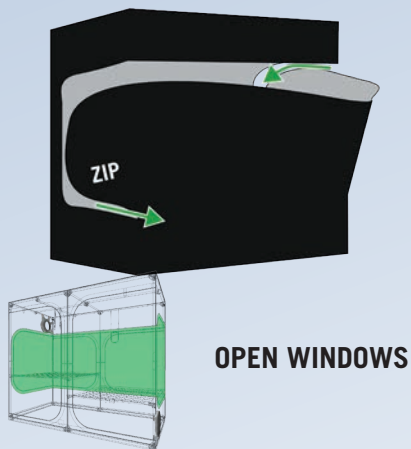

**OPEN ALL ACCESSES THEN
PUT THE CANVAS ON**



**ALLE ZUGÄNGE ÖFFNEN DANN
LEGEN SIE DIE LEINWANDE AB**



**OUVRIER TOUT LES ACCÈS PUIS
METTRE LA TOILE**



**ALLE TOEGANGEN OPENSTELLEN
DAN ZET JE HET DOEK OP**



**ABRIR TODOS LOS ACCESOS
LUEGO PONTE EL LIENZO**



**APRIRE TUTTI GLI ACCESSI POI
METTERE LA TELA DI CANAPA SU**

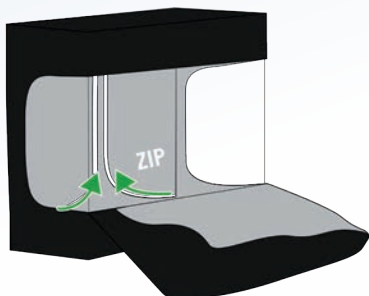
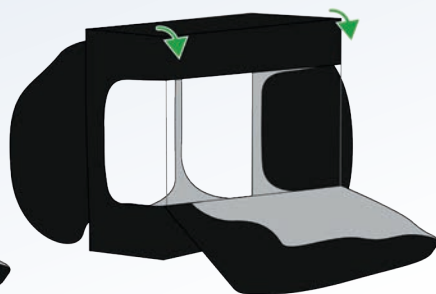
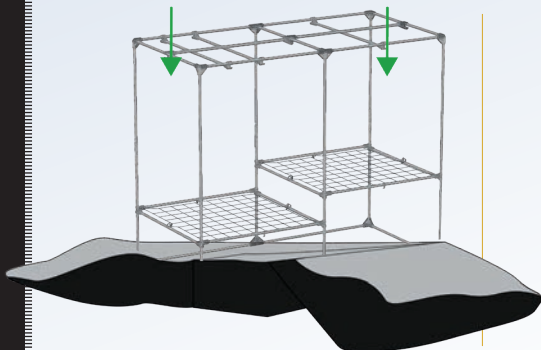

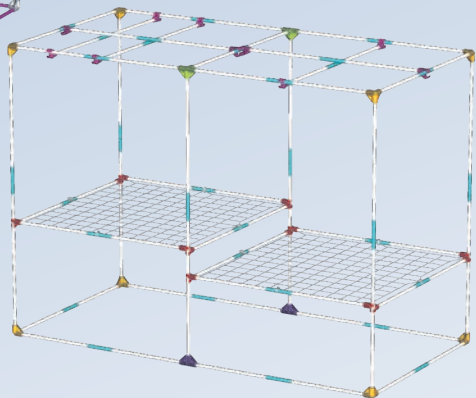
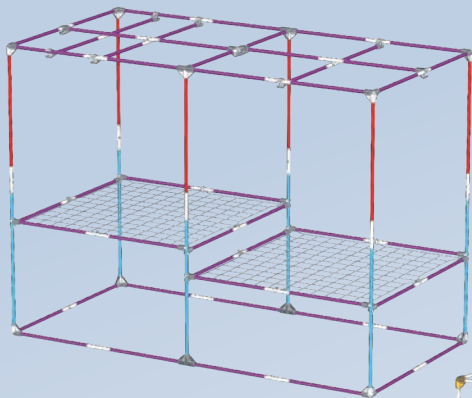

**VIDEO ASSEMBLY
TENT DR240W**



- 6x T25-120
- 6x T25-100
- 52x T25-75
- 32x T25-Link



8x C25-Y



2x C25-K



2x C25-T



16x C25-SB



10x C25-H

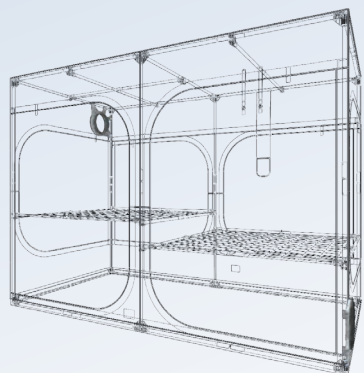

**VIDEO ASSEMBLY
DUCTING FLANGE**



**VIDEO ASSEMBLY
CABLE FLANGE**



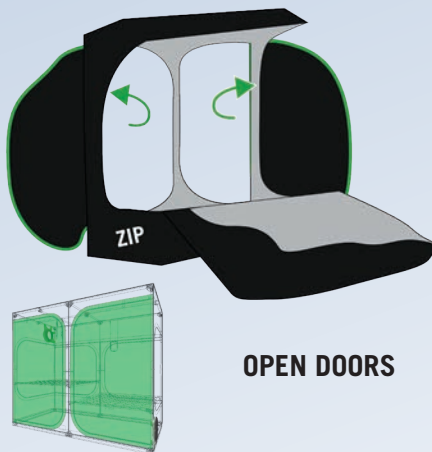
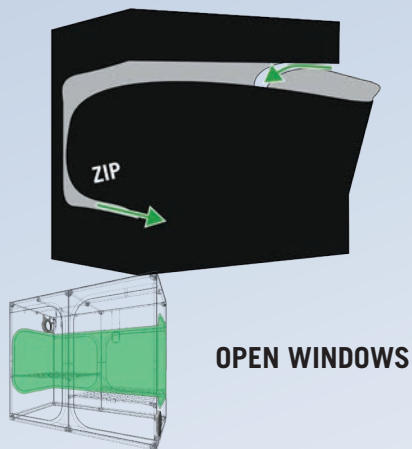

OPEN ALL ACCESSES **THEN**
PUT THE CANVAS ON



ALLE ZUGÄNGE ÖFFNEN **DANN**
LEGEN SIE DIE LEINWANDE AB



OUVRIER TOUT LES ACCÈS **PUIS**
METTRE LA TOILE



ALLE TOEGANGEN OPENSTELLEN
DAN ZET JE HET DOEK OP



ABRIR TODOS LOS ACCESOS
LUEGO PONTE EL LIENZO



APRIRE TUTTI GLI ACCESSI **POI**
METTERE LA TELA DI CANAPA SU

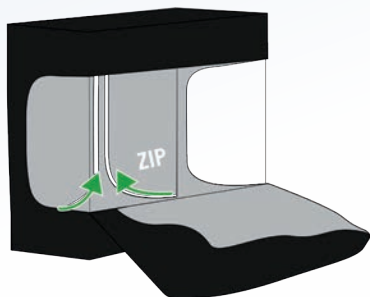
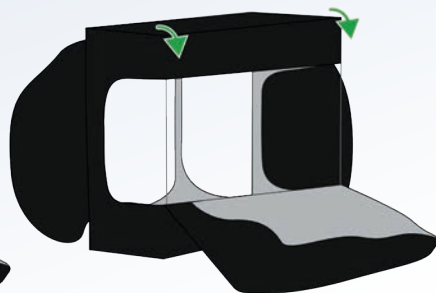
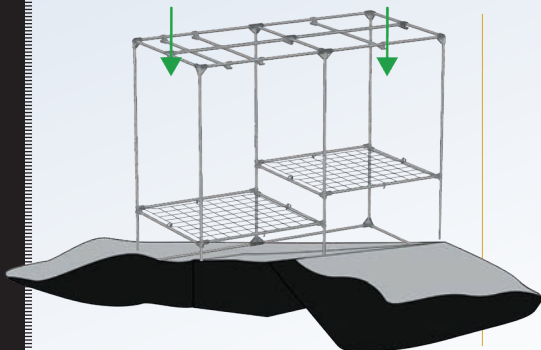

METRIC

PROFESSIONAL DARK ROOM				HANDLING			LIGHTING		VENTILATION ADVISED			
REF	DESIGNATION	REV	WGT Net lb	#	L in	Weight Per Pole	Weight Per Tent	LED Advised Intensive	HPS Advised Intensive	VOL cf	HPS/HOT every 30-60s Extraction	LED/COLD every 1-2 min Intake
DR150	Dark Room 5' x 5' x 7'	R4.00	59.1	3	59	40 lb	120 lb	1 LED960	1 HPS1000W	177	355 cfm	177 cfm
DR240	Dark Room 8' x 8' x 6 1/2'	R4.00	101.9	9	47	40 lb	360 lb	4 LED640	4 HPS600W	440	881 cfm	440 cfm
DR300	Dark Room 10' x 10' x 7'	R4.00	146.8	10	47	40 lb	400 lb	4 LED960	4 HPS1000W	440	881 cfm	440 cfm
DR240W	Dark Room 8' x 4' x 6 1/2'	R4.00	69.9	5	47	40 lb	200 lb	2 LED640	2 HPS600W	223	445 cfm	223 cfm
DR300W	Dark Room 10' x 5' x 7'	R4.00	94.6	5	59	40 lb	200 lb	2 LED960	2 HPS1000W	352	703 cfm	352 cfm

IMPERIAL

PROFESSIONAL DARK ROOM				HANDLING			LIGHTING		VENTILATION ADVISED			
REF	DESIGNATION	REV	WGT Net lb	#	L in	Weight Per Pole	Weight Per Tent	LED Advised Intensive	HPS Advised Intensive	VOL cf	HPS/HOT every 30-60s Extraction	LED/COLD every 1-2 min Intake
DR150	Dark Room 5' x 5' x 7'	R4.00	59.1	3	59	40 lb	120 lb	1 LED960	1 HPS1000W	177	355 cfm	177 cfm
DR240	Dark Room 8' x 8' x 6 1/2'	R4.00	101.9	9	47	40 lb	360 lb	4 LED640	4 HPS600W	440	881 cfm	440 cfm
DR300	Dark Room 10' x 10' x 7'	R4.00	146.8	10	47	40 lb	400 lb	4 LED960	4 HPS1000W	440	881 cfm	440 cfm
DR240W	Dark Room 8' x 4' x 6 1/2'	R4.00	69.9	5	47	40 lb	200 lb	2 LED640	2 HPS600W	223	445 cfm	223 cfm
DR300W	Dark Room 10' x 5' x 7'	R4.00	94.6	5	59	40 lb	200 lb	2 LED960	2 HPS1000W	352	703 cfm	352 cfm



info@secretjardin.com

Secretjardin_

Secret Jardin Official

Secret Jardin

www.secretjardin.com